

01

0137

DIN circular connectors



DIN plug, straight version, shielded, with locking catch, metal housing, bend protection and solder terminals

01

0137

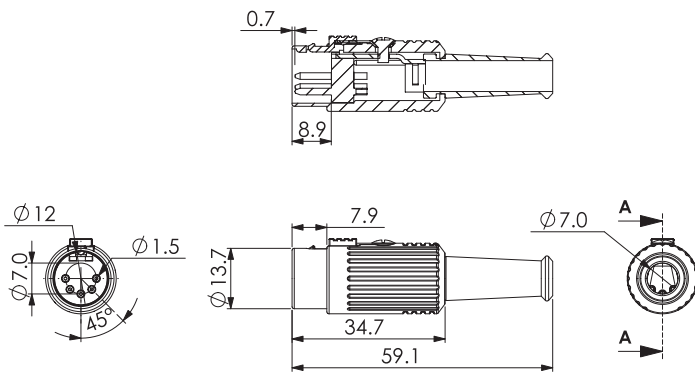

DIN 41524

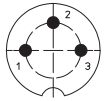

0137 03

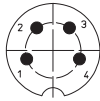

0137 04

DIN 41524

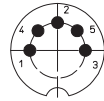

0137 05

DIN 45322

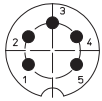

0137 05-1

DIN 45322

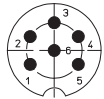

0137 06

DIN 45329

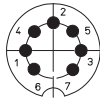

0137 07-1

DIN 45326

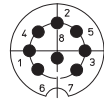

0137 08-1

Environmental conditions

Temperature range -20 °C/+85 °C

Materials

Insulating body	ABS, V-0 according to UL94
Contact spring	CuZn, silver-plated
Contact bush	CuSn, silver-plated
Contact pin	CuZn, silver-plated
Strain relief	steel, nickel-plated
Housing	Zn alloy, nickel-plated
Locking	Zn alloy, nickel-plated
Leaf spring	steel
Bend protection sleeve	PVC
Screw	steel, nickel-plated



Connectable conductors for solder area

Section	≤ AWG 18 (0,75 mm ²)
Cable diameter	7,0 mm

Electrical data (at T_{amb} 20 °C)

Rated current	≤ 4 A
Rated voltage	60 V AC
Rated impulse voltage	250 V AC RMS/60 s
Insulation resistance	≥ 100 MΩ

Associated products

Counterparts			
 0103	 0105	 010599	

01

0137

Designation	Pole Number	PU (Pieces)	MDQ (Pieces)
0137 03	3	50	150
0137 04	4	50	150
0137 05	5	50	150
0137 05-1	5	50	150
0137 06	6	50	150
0137 07-1	7	50	150
0137 08-1	8	50	150

Packaging:

in individual plastic bags, in a cardboard box