

REV. 01	DESCRIPTION New Initial.

THIS DOCUMENT IS SUBJECT TO CHANGE WITHOUT NOTICE. IT IS CONFIDENTIAL AND A PROPERTY OF Amphenol LTW. DISCLOSURE TO THIRD PARTY HAS TO BE AUTHORIZED BY Amphenol LTW.

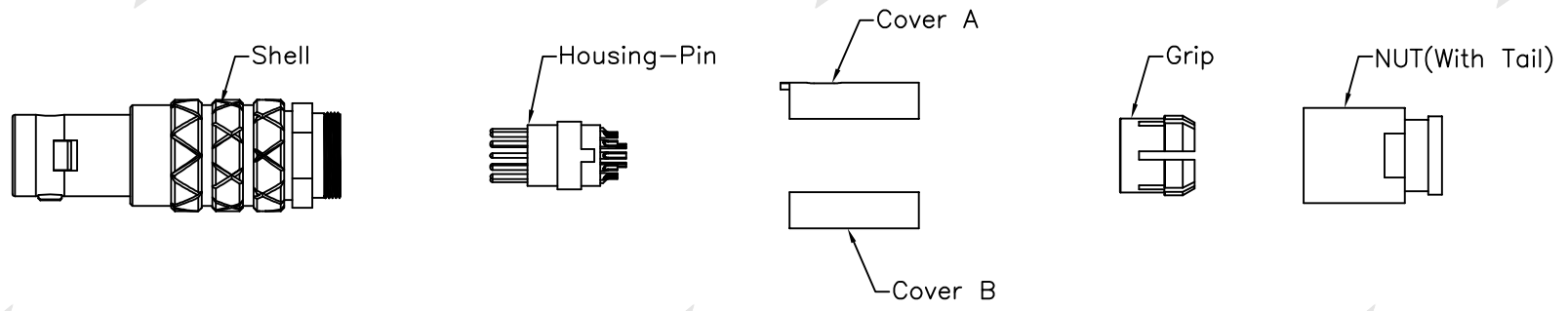
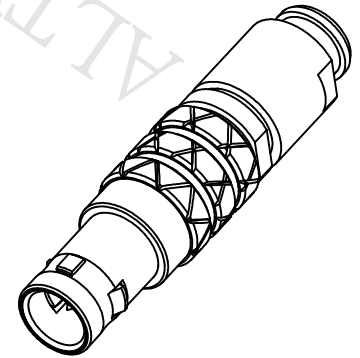
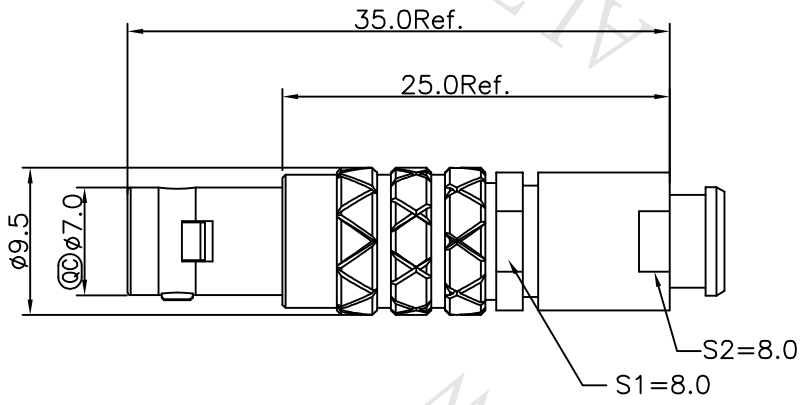

Notes:
 * Ⓞ Important Dimensions To Check.
 * Pin: Copper Alloy, Gold Plated.

UNIT:mm	
TOLERANCE ±0.5MM	

TITLE FLO 0B FI CONNECTOR	
SCALE Free	SHEET 1 OF 2
REV. A	SIZE A4
Ⓞ :Inspection Item	

Amphenol LTW
 安費諾亮泰企業股份有限公司

ITEM NO FLBB-XXFGMS-XCP-2XX	DRAWN BY Ouyang
DWG NO FLBB-XXFGMS-XCP-2XX	CHECKED BY Mafei
CUSTOMER ALTW	APPROVED BY Jerry

DATE 2018/09/05
DATE 2018/09/05
DATE 2018/09/05

THIS DOCUMENT IS SUBJECT TO CHANGE WITHOUT NOTICE. IT IS CONFIDENTIAL AND A PROPERTY OF Amphenol LTW. DISCLOSURE TO THIRD PARTY HAS TO BE AUTHORIZED BY Amphenol LTW.



FLBB-XXFGMS-XCP-2XX

- CABLE OD ①
- KEY POINT ②
- PIN CONFIGURATION ③
- SIZE(CONNECTOR)

OB-SERIES CABLE COLLET(CABLE OD)

CABLE CLAMP SET		CABLE DIA RANGE	
TYPE	CODE ①	MAX	MIN
FLBB-XXFGMS-XCP-2XX	01	3.2	2.2
	04	4.2	3.2
	07	5.2	4.2

KEY POINT ②

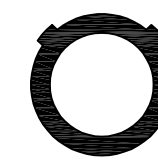
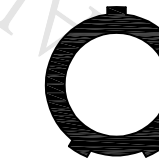
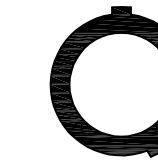
CODE	G	A	B	C	J	F
	0°	30°	60°	90°	45°	155°
GRAPHIC						

PIN CONFIGURATION (Solder Definition) ③

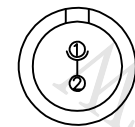
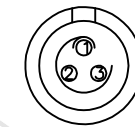
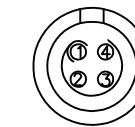
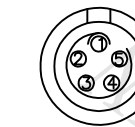
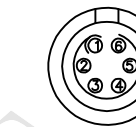
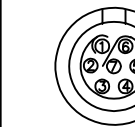
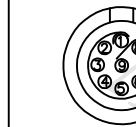
GRAPHIC							
	2 PIN	3 PIN	4 PIN	5 PIN	6 PIN	7 PIN	9 PIN

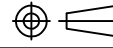
UNIT:mm		TITLE FLO OB FI CONNECTOR	
TOLERANCE ±0.5MM	SCALE Free	SHEET 2 OF 2	
REV. A	SIZE A4	◎ : Inspection Item	

Amphenol LTW
安費諾亮泰企業股份有限公司

ITEM NO FLBB-XXFGMS-XCP-2XX	DRAWN BY Ouyang	DATE 2018/09/05
DWG NO FLBB-XXFGMS-XCP-2XX	CHECKED BY Mafei	DATE 2018/09/05
CUSTOMER ALTW	APPROVED BY Jerry	DATE 2018/09/05